

JIANGSU WUJIN KAILI ELECTRONIC FACTORY

SPECIFICATION SHEET

ELECTRONIC SPECIFICATION:



HY2280A SERIES:

Type	UNIT	HY2280A
*Min. Sound Output at 10cm	dB	85
Rated Voltage	Vp-p	9
Operating Voltage	Vp-p	1~30
Resonant Frequency	Hz	4000±500
*Max. Current Consumption	mA	2
Capacitance at 1,000HZ	pF	24000±30%
Operating Temperature	℃	-20 ~ +70
Storage Temperature	℃	-30 ~ +80
Weight	g	2.1

* Value applying at rated voltage

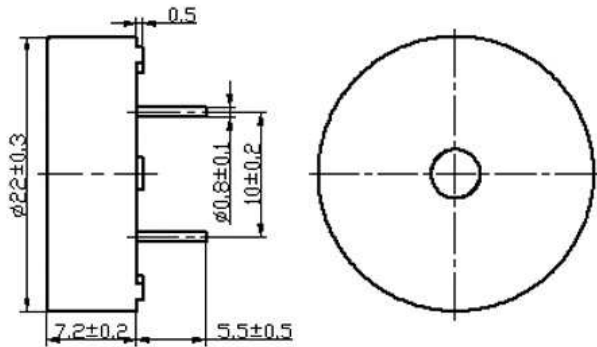

JIANGSU WUJIN KAILI ELECTRONIC FACTORY

Miaoqiao Town, Changzhou city, Jiangsu, China 213167

TEL:0086-519-6462433; 6712320

FAX:0086-519-6471336; 6712320

E-mail: kailiec@jmail.com.cn

<http://www.kaili-buzzer.com/>